

KRF16-6

- Material: Cu 99.95%, tin plated Cu/Sn.
- With inspection holes.
- For stranded (class 2), multi-stranded (class 5) and very flexible (class 6) Cu conductors according to IEC 60228, for multi-stranded Cu conductors contact crimping using the Dual system is recommended.



Example of marking KRF: 17 (neck) Elpress logotype 70 10F (palm)

17 = Die No. 70 = mm² 10 = palm hole for M10 F = type KRF for stranded, flexible and very flexible conductors.

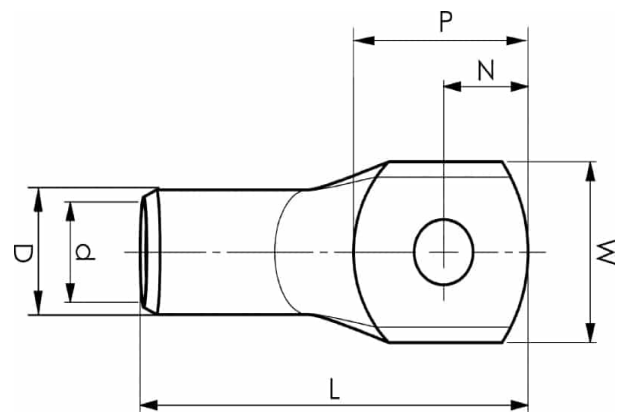

Item number: **7301-012100**
EAN: **7393487005921**

W (mm): **13**
N (mm): **8**
N1 (mm): **9**
P (mm): **17**
f (mm): **1.1**
d (mm): **6**
D (mm): **9**
L (mm): **34**
t (mm) - palm thickness: **2.9**
s (mm) - strip length: **11**

Screw: **M6**
Inspection hole: **Yes**

AWG/MCM Cu: **6 AWG**
mm² Cu: **16**