

KRF25-12

- Material: Cu 99.95%, tin plated Cu/Sn.
- With inspection holes.
- For stranded (class 2), multi-stranded (class 5) and very flexible (class 6) Cu conductors according to IEC 60228, for multi-stranded Cu conductors contact crimping using the Dual system is recommended.



Example of marking KRF: 17 (neck) Elpress logotype 70 10F (palm)

17 = Die No. 70 = mm² 10 = palm hole for M10 F = type KRF for stranded, flexible and very flexible conductors.

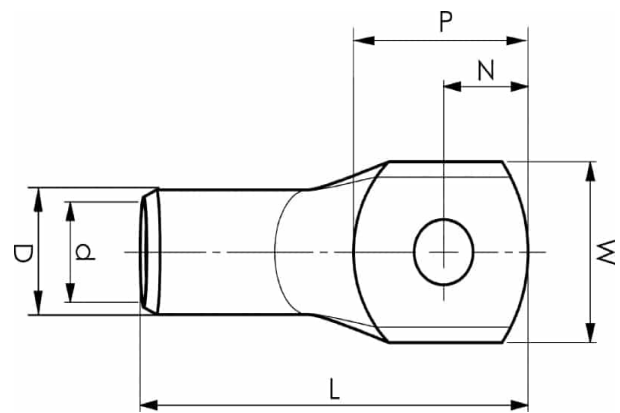

Item number: **7301-012900**
EAN: **7393487005990**

W (mm): **22**
N (mm): **12**
N1 (mm): **13**
P (mm): **25**
f (mm): **1**
d (mm): **8**
D (mm): **11**
L (mm): **47**
t (mm) - palm thickness: **2.1**
s (mm) - strip length: **13**

Screw: **M12**
Inspection hole: **Yes**

AWG/MCM Cu: **4 AWG**
mm² Cu: **25**