

# KRF70-12

- Material: Cu 99.95%, tin plated Cu/Sn.
- With inspection holes.
- For stranded (class 2), multi-stranded (class 5) and very flexible (class 6) Cu conductors according to IEC 60228, for multi-stranded Cu conductors contact crimping using the Dual system is recommended.



## Example of marking KRF: 17 (neck) Elpress logotype 70 10F (palm)

17 = Die No. 70 = mm<sup>2</sup> 10 = palm hole for M10 F = type KRF for stranded, flexible and very flexible conductors.

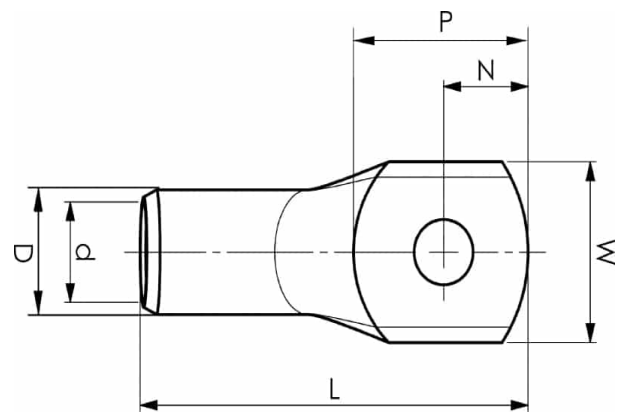

Item number: **7301-014200**  
EAN: **7393487006126**

W (mm): **25**  
N (mm): **12**  
N1 (mm): **13**  
P (mm): **25**  
f (mm): **1**  
d (mm): **13**  
D (mm): **17**  
L (mm): **58**  
t (mm) - palm thickness: **3.9**  
s (mm) - strip length: **22**

Screw: **M12**  
Inspection hole: **Yes**

AWG/MCM Cu: **2/0 AWG**  
mm<sup>2</sup> Cu: **70**