

KRF185-12

- Material: Cu 99.95%, tin plated Cu/Sn.
- With inspection holes.
- For stranded (class 2), multi-stranded (class 5) and very flexible (class 6) Cu conductors according to IEC 60228, for multi-stranded Cu conductors contact crimping using the Dual system is recommended.



Example of marking KRF: 17 (neck) Elpress logotype 70 10F (palm)

17 = Die No. 70 = mm² 10 = palm hole for M10 F = type KRF for stranded, flexible and very flexible conductors.

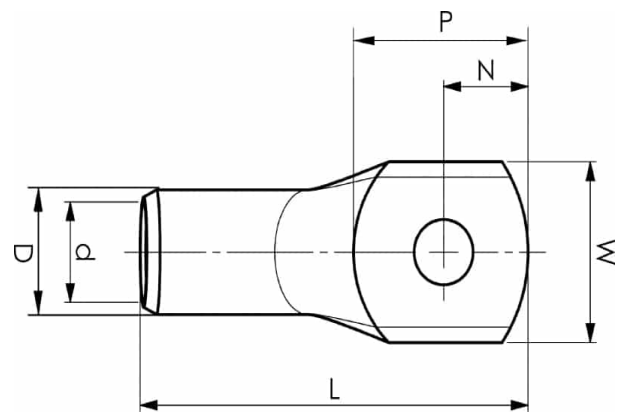

Item number: **7301-015300**
EAN: **7393487006232**

W (mm): **39**
N (mm): **15**
N1 (mm): **16**
P (mm): **31**
f (mm): **1**
d (mm): **21**
D (mm): **27**
L (mm): **86**
t (mm) - palm thickness: **5.9**
s (mm) - strip length: **37**

Screw: **M12**
Inspection hole: **Yes**

AWG/MCM Cu: **350 MCM**
mm² Cu: **185**