

KRF95-12

- Material: Cu 99.95%, tin plated Cu/Sn.
- With inspection holes.
- For stranded (class 2), multi-stranded (class 5) and very flexible (class 6) Cu conductors according to IEC 60228, for multi-stranded Cu conductors contact crimping using the Dual system is recommended.



Example of marking KRF: 17 (neck) Elpress logotype 70 10F (palm)

17 = Die No. 70 = mm² 10 = palm hole for M10 F = type KRF for stranded, flexible and very flexible conductors.

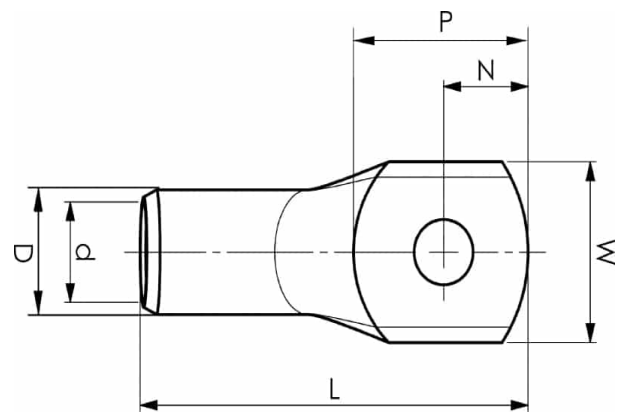

Item number: **7301-014500**
EAN: **7393487006157**

W (mm): **29**
N (mm): **15**
N1 (mm): **16**
P (mm): **31**
f (mm): **1**
d (mm): **15**
D (mm): **20**
L (mm): **69**
t (mm) - palm thickness: **4.9**
s (mm) - strip length: **25**

Screw: **M12**
Inspection hole: **Yes**

AWG/MCM Cu: **3/0 AWG**
mm² Cu: **95**